

R. & A. **Precast** **Architectural Dressing** **BROCHURE/CATALOGUE**

*Manufacturers of Reconstituted Stone Products
to the Trade and Retailer*

Est. 1983

Tel: 01268 732077 Fax: 01268 572570

Email: info@raprecast.co.uk

Web: www.raprecast.co.uk





History

Formed in 1983, R & A Precast has been involved in numerous projects, with both residential and commercial properties. In recent years we have increased our range to incorporate the growing demands for reconstituted stonework. Indeed, we have gained a reputation for the manufacture of quality products tailored to meet our clients' specific requirements.



As most architectural dressing is designed to the customers' own specification, we would welcome the opportunity of discussing your individual requirements.





An essential feature of our reconstituted stone is that the surface bears an extremely close resemblance to natural stone, which makes distinction between the two very difficult. This also has the advantage of being less expensive than quarried stone. To produce excellent products the moulds must be manufactured to the highest standard. With the use of our extensive mould and pattern making workshop, we can produce a first-class mould from either wood, fibre glass, steel or latex.



Material

Our reconstituted stone consists of various materials carefully blended together. The dominant feature is a crushed Portland aggregate. Furthermore we can recreate the effect of Bathstone using colouring pigments. These pigments are also used when there is a need to tone down the freshness of new stone to achieve a weathered look on refurbishment projects.



All pieces are individually manufactured by hand, with careful attention to the finish of each product. Although the standard pieces produced are intended as a decorative façade being supported by steelwork, individual pieces that need to be load-bearing can be easily manufactured with guidance of an architect or structural engineer.



Handling

Reconstituted stone must be handled with great care at all times. During manufacture, air temperature and humidity are carefully monitored. Once pieces have had time to cure they are laid upon strips of polystyrene, palletised and then encased in polythene wrap, prior to goods being transported.

Once on site, we recommend that all pallet wrap remain intact to keep units clean and safe from damage until ready for use.

These products have been used successfully, not only in new building developments, but also in the refurbishment of older properties throughout the country.





Whilst our involvement tends to be mainly in the residential sector, in terms of providing products to new and refurbished developments, our range of stonework has been extended to incorporate various commercial and non-residential projects many of which are unique.





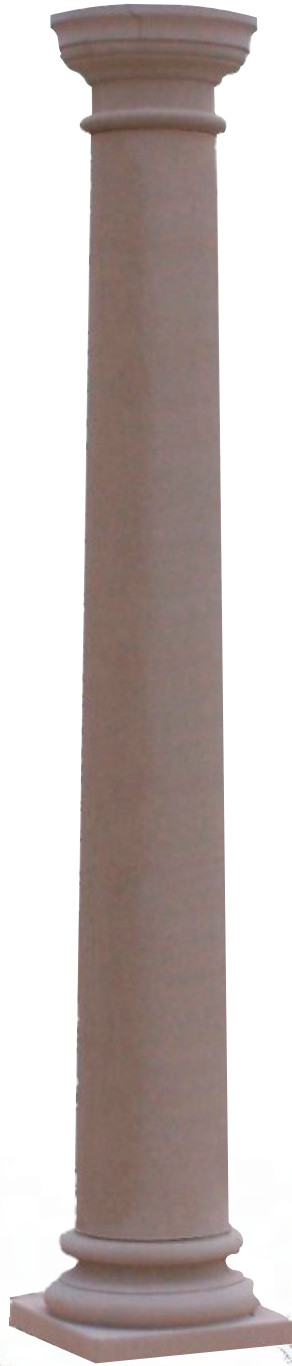

Catalogue

Window Cills

The window cills shown are our standard range designed to suit either a one or two brick course. They can be either manufactured with or without tooling. Water bar grooves can be cut into cills on request. All window cills over 1500mm in length will be manufactured in two pieces. When ordering cills please state whether the dimension is the opening or overall length.

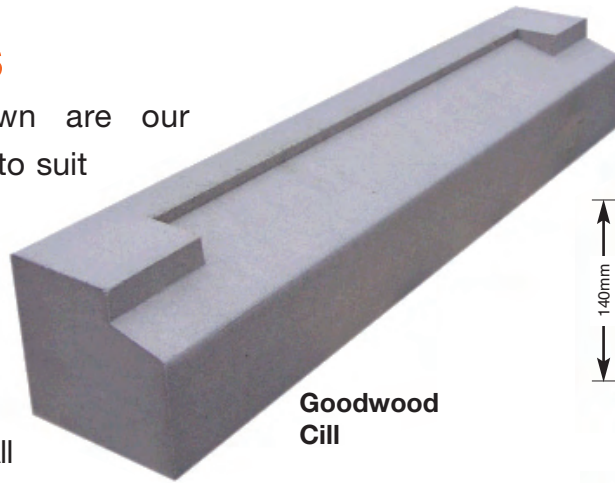

Goodwood Cill

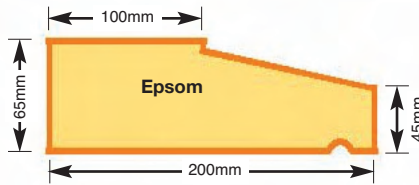
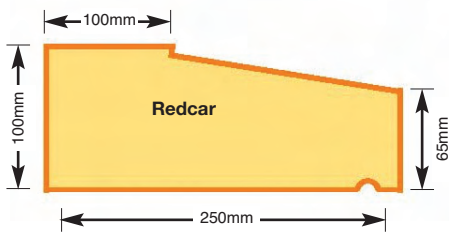
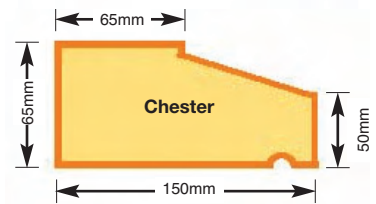
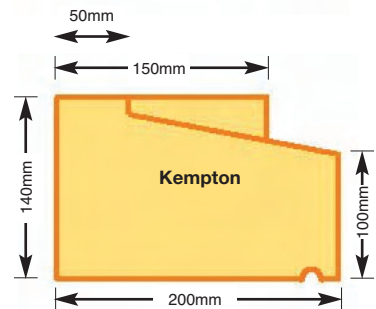
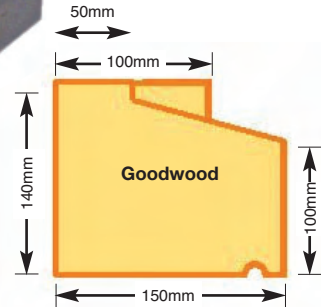

Illustration shown Splayed Head with Keystones

Lintels/Heads

These two types of lintels have become the most popular used. The Plain Head Lintel can be manufactured to be load-bearing with the guidance of a structural engineer. The Splayed Head Lintel can be used as it is or with an integral keystone. All non-loadbearing lintels must be supported by a steel lintel, which can be easily sourced from any reputable builders merchants. Custom made lintels are available on request.



Window Opening

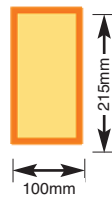

Window Opening



Window Opening

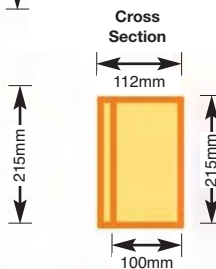

Wall Quoins

Q4152 is designed for four courses of brick, whereas all the others are designed for three courses of brick. Q33115 has no chamfer. When bedding quoins allow 6mm joint between horizontal and a 5mm joint between vertical. Custom-made wall quoins and ashlar blocks are available on request.

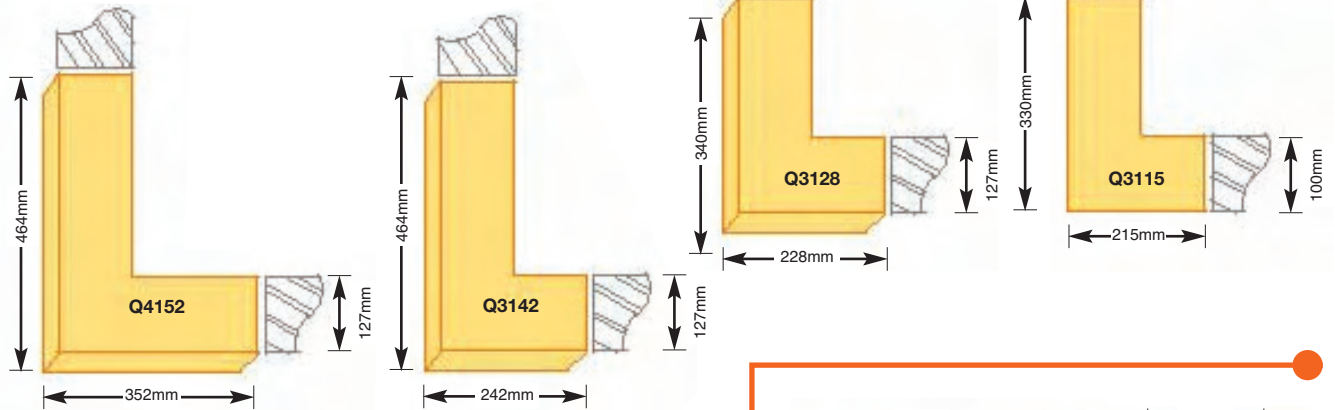
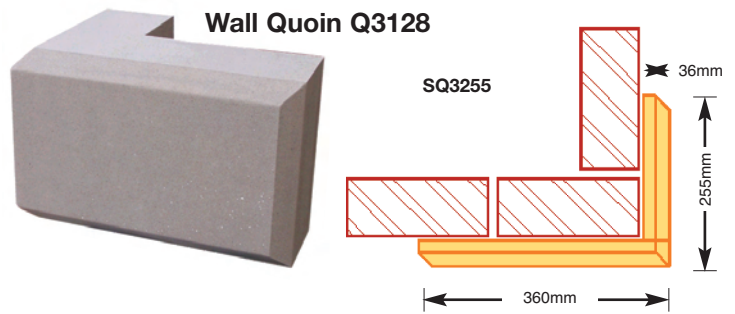

Due to demand, we have introduced a 'stick-on' quoin, SQ3255. These are glued on using and epoxy resin, available from most builders merchants.

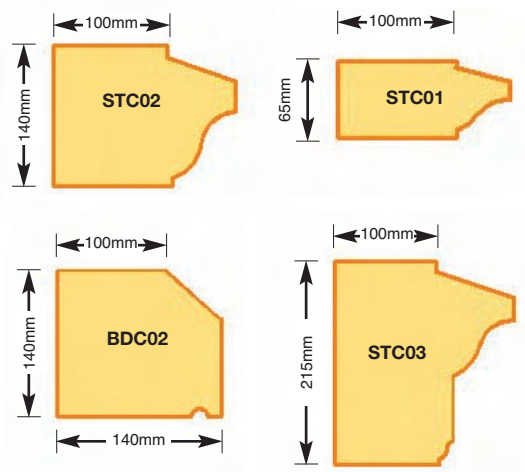

Banding/String Course

Internal and external corners and special angles are available. Although not shown in our standard range, stainless steel restraints are available at an extra cost. Custom-made Banding/String Course are available

on request.

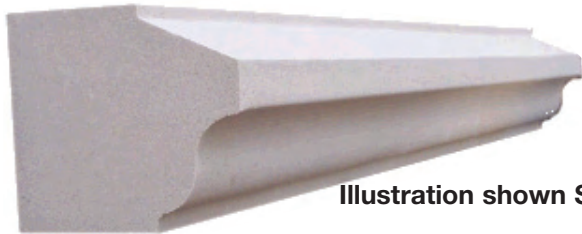
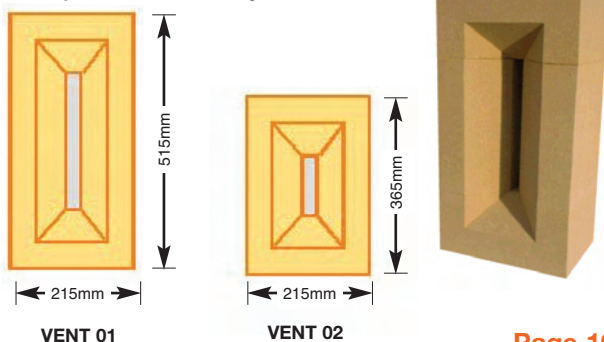

Illustration shown STC02

Gable Vent Slots

The two gable vent slots shown above come in four pieces and are designer to be either blind or incorporated in a fly-mesh.



Plinths

Two designs of plinths are available as standard. PTH02 will complement either FCP coping or PLC pier caps. Standard length is 1000mm. Custom-made plinths are available on request.

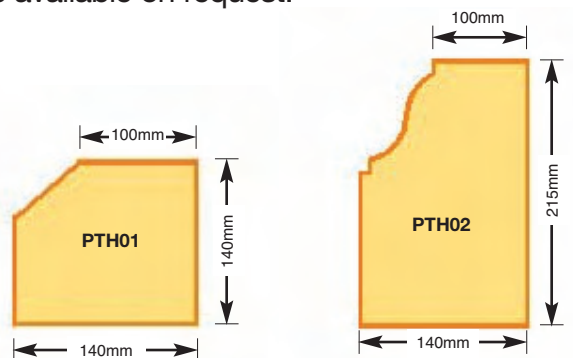

Keystones

The Keystones below show the dimension of 215mm in height although 290mm is an option. Custom-made keystones are available on request.

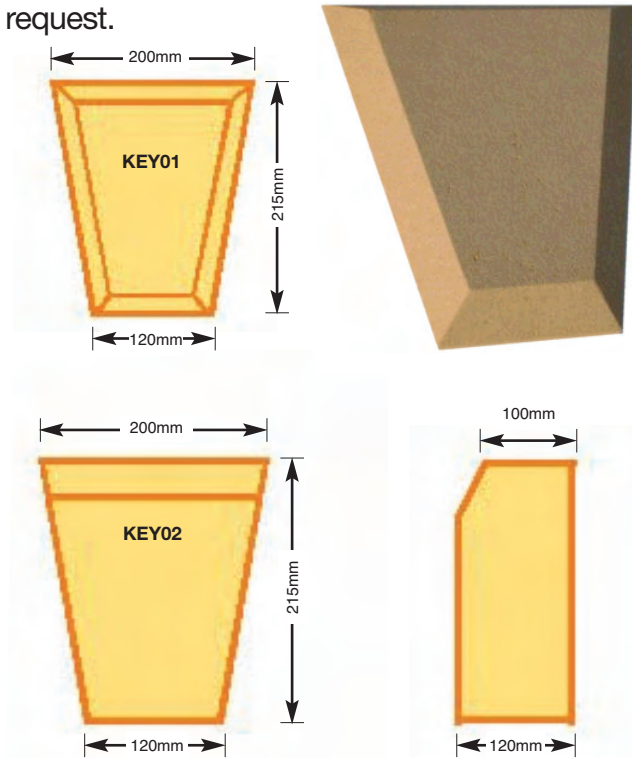

Corbels

Although over the years we have produced many different shapes and sizes of corbels these two below are the most popular. The width is generally 100mm but in several cases it requires the front to return by 215mm and would be handed. Please specify this at the time of order. Custom-made corbels are available on request.

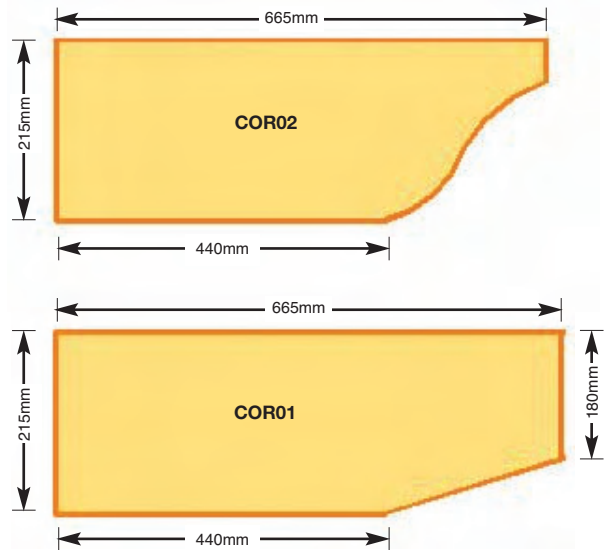

Steps & Risers

Two designs are available as standard. The exact size, shape and length will be made to the customer's own requirements. Custom-made steps and risers are available on request.

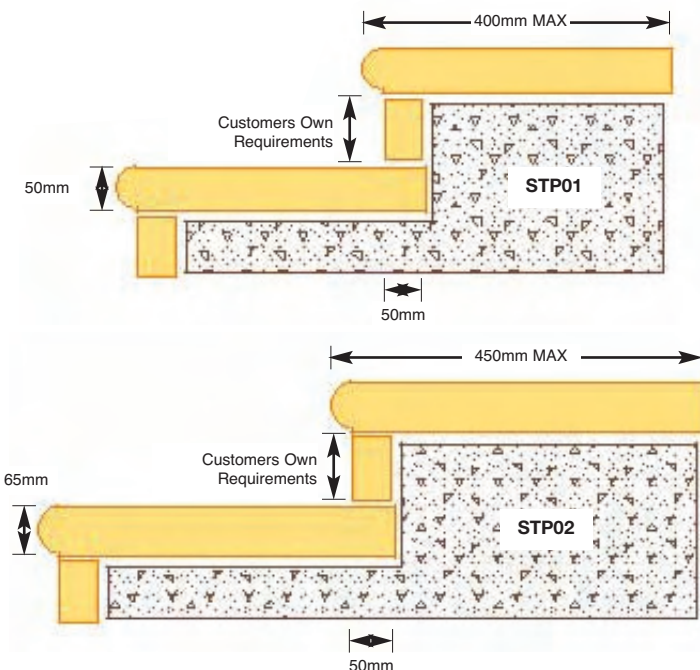

Name Plaques & Date Stones

We don't carry a standard range of name plaques or date stones, all are manufactured to customer's requirements. The only limitation is your imagination! All plaques are etched by a qualified stone mason.



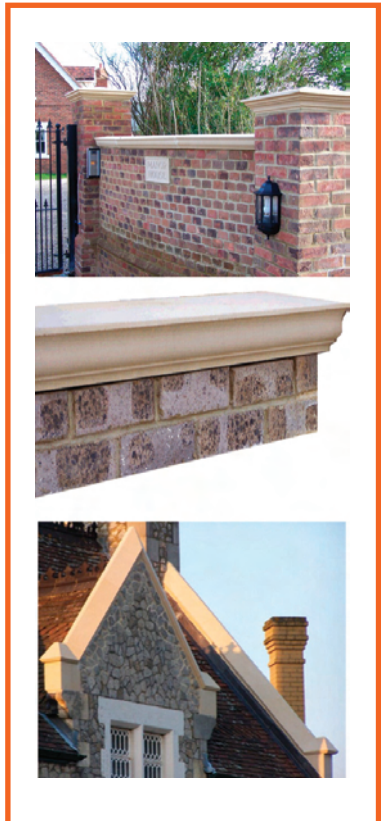
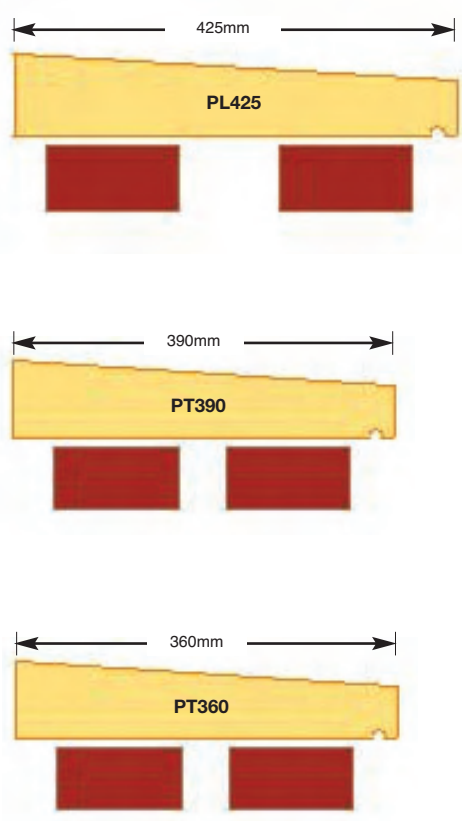
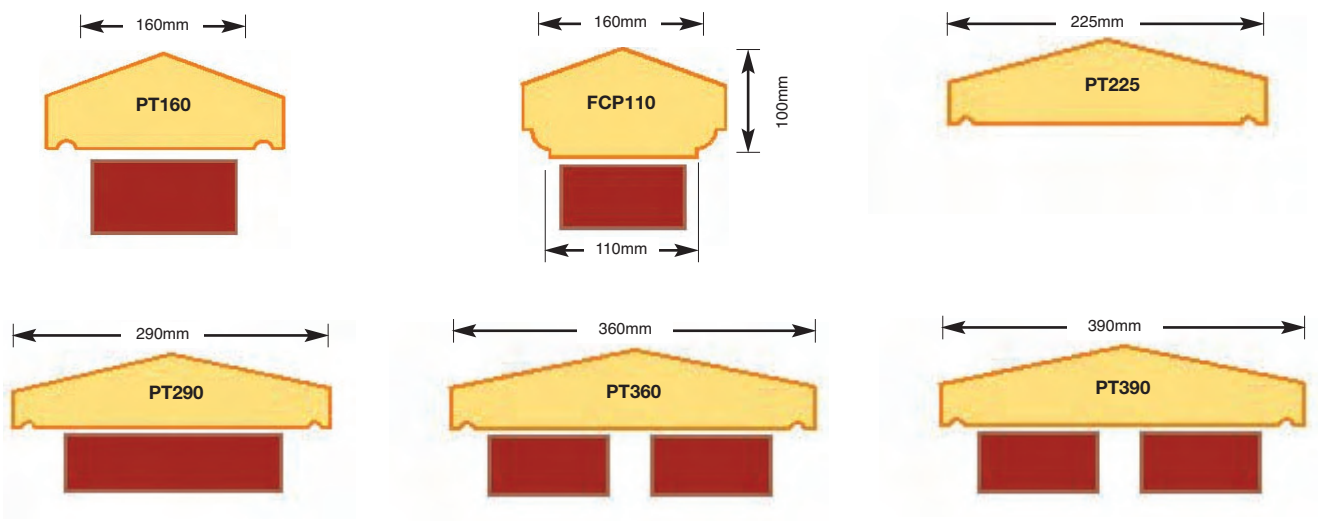

Copings

These are just a small selection of many different copings available. Stainless steel dowels or coping restraints are available on request.

These drawings are not to scale.

Unless otherwise stated the thickness of these copings are 75mm > 50mm radius.

A range of radius copings are available.

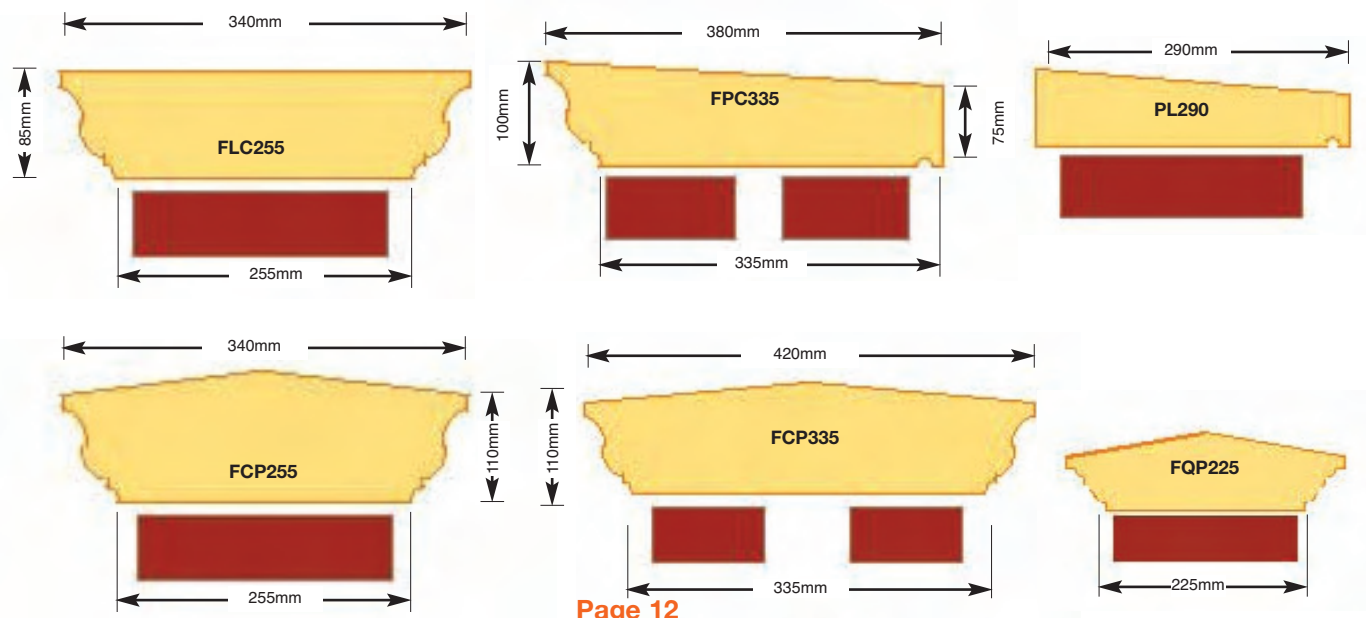

Pier Caps

Pier caps shown are our standard range. Custom-made pier caps are available on request. BC570 and BC675 come in three pieces and have lifting inserts cast into the apex of the cap.

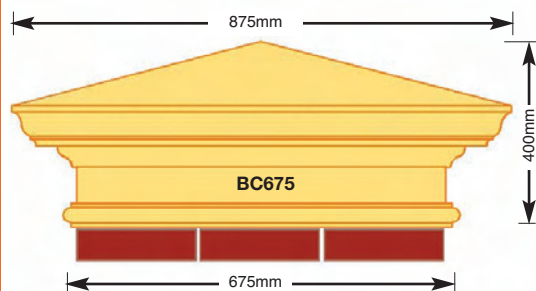
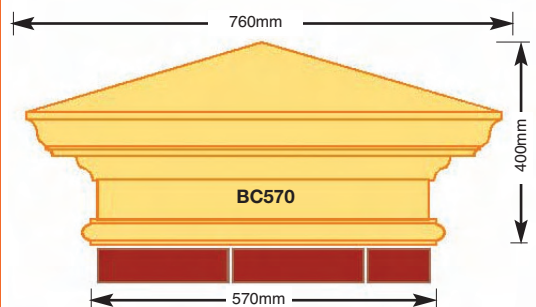
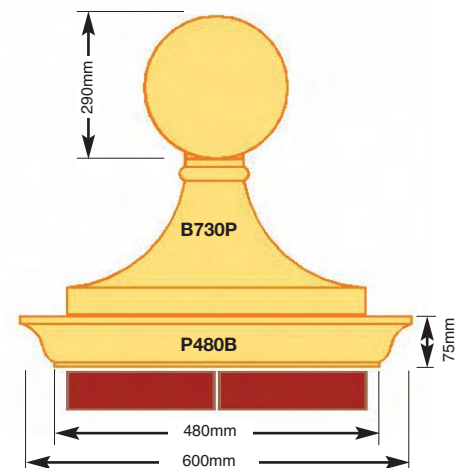
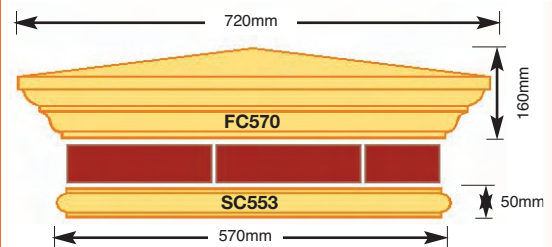
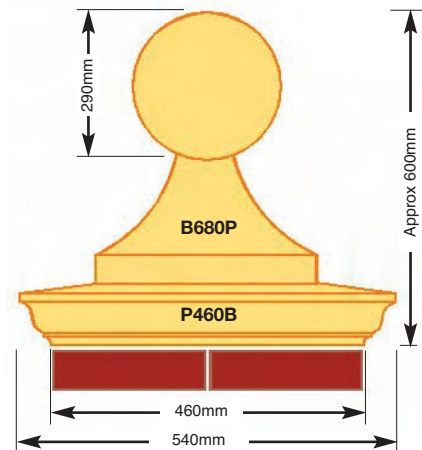
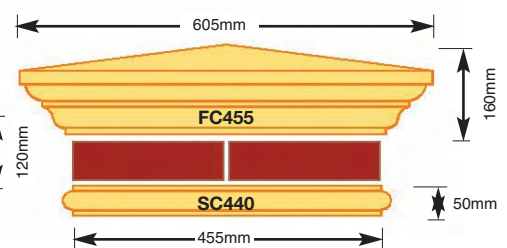
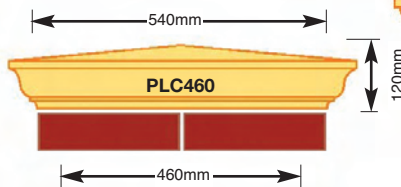
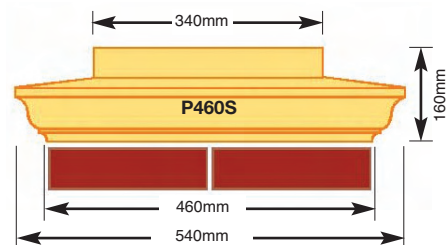
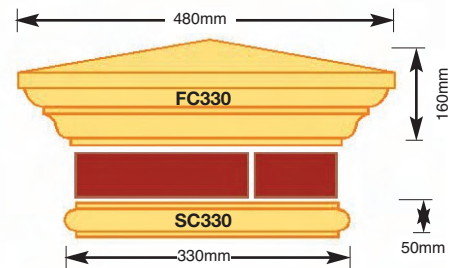
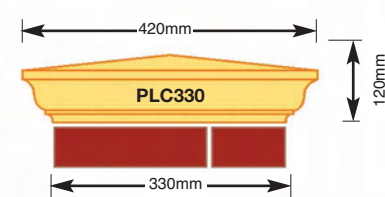
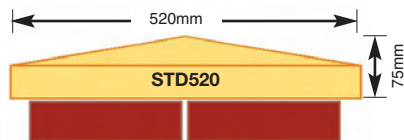
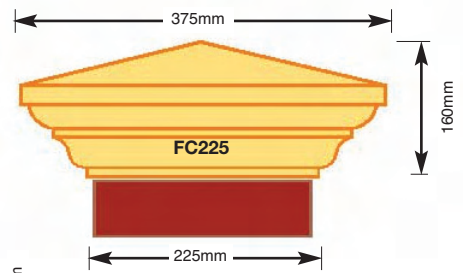
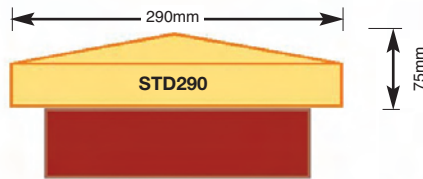
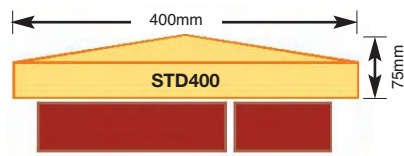

Balustrade

Our standard range of balustrade will complement any garden or balcony. The illustration shown incorporates an under coping which does not necessarily need to be used, and has an apex top, which could be manufactured flat if requested. All balustrades come with stainless steel dowels cast in the top and bottom.

The total height shown includes 5mm bed joint.

A larger under coping can also be manufactured to increase the overall height to 1100mm. Custom-made balustrade is available on request.

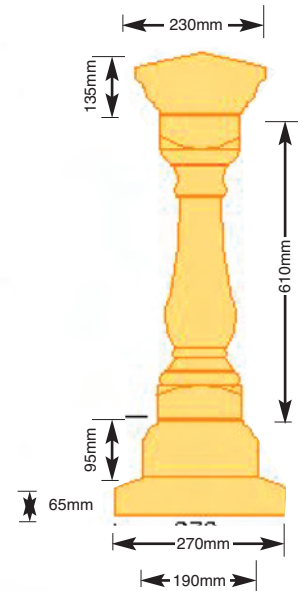
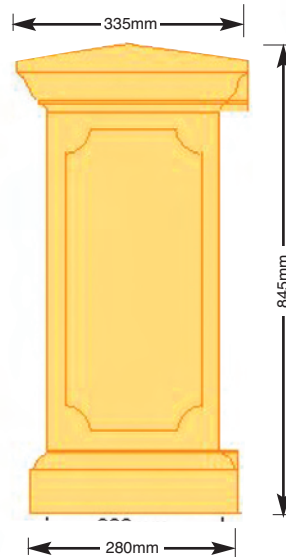
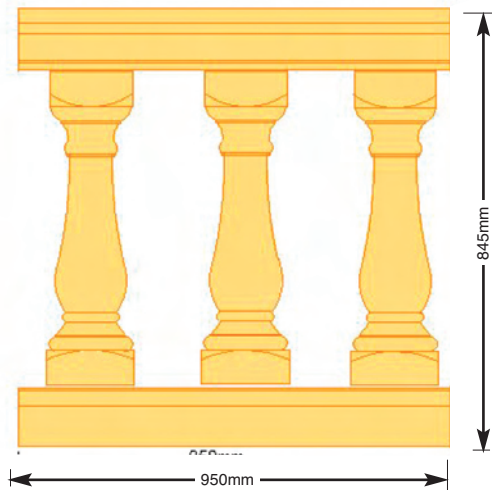

Corner Pier



Intermediate Pier



End Pier



Freestanding Pier



Columns & Porticos

All of our porticos are made to customer's individual choice. As far as porticos are concerned, there is no standard size or design. However, as you can see from the sketches and photos, we hopefully can accommodate any requirements you may have.

Please note: We only supply the stonework. Additional items will be required such as reinforcing etc.

The columns that we manufacture are in the Tuscan style with plain shafts. All columns have a hollow core to enable the use of either a steel support or reinforced concrete. If using the latter, the inside should be lined with polystyrene to allow for expansion.

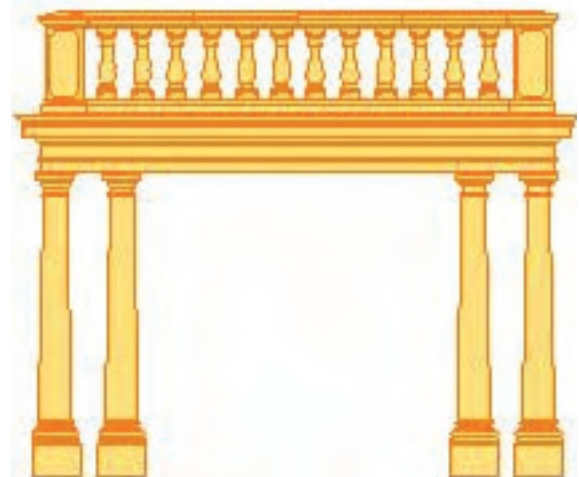
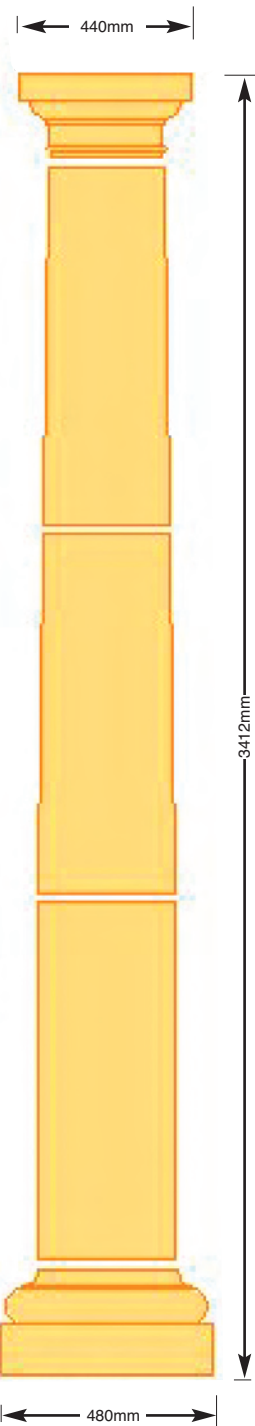
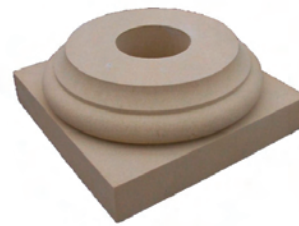
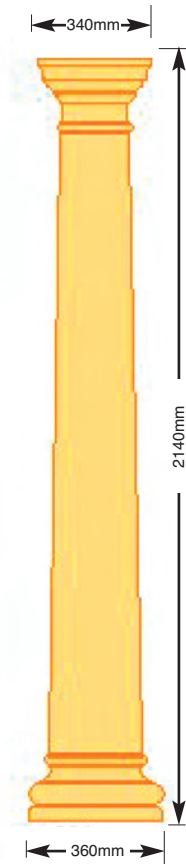

BROCHURE/CATALOGUE



R. & A. Precast Architectural Dressing

Rear of Fairlawns, Woodham Road
Battlesbridge, Essex SS11 7QW
Telephone: 01268 732077
Fax: 01268 572570
Email: info@raprecast.co.uk
Website: www.raprecast.co.uk

